

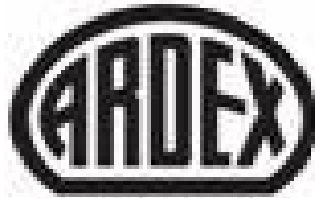

FUNCTION. DESIGN. QUALITY.



Building Products Ireland



## Product Information

# Preperation BAL Prime APD



- Stabilises dusty tiling substrates
- Reduces background porosity

## prime APD

### Acrylic Primer for Walls & Floors

#### USE FOR:

- preparing floor and wall backgrounds prior to fixing of ceramic/mosaic and natural stone tiles
- dry/wet - interior/exterior

#### USE UNDILUTED ON:

- plaster walls/plasterboard when using a BAL cementitious powder adhesive
- tongue & groove floorboards
- anhydrite screed floors

#### USE DILUTED 1:1 with clean water on:

- dusty/porous plaster walls when using a BAL ready-mixed adhesive
- cement: sand screed/concrete floors

**MAY BE TILED AFTER:** 30 minutes

TYPICAL COVERAGE per pack

**UNDILUTED**

**DILUTED 1:1 WITH CLEAN WATER**

**SIZE: 2.5L**

12.5 - 25m<sup>2</sup>

25-50m<sup>2</sup>

# BAL MicroFlex Grouts



- Water/frost-resistant
- Built-in admixture for increased flexibility and high bond strength at edges of tiles/mosaics
- Contains Microban® antibacterial protection: for extra hygiene

## microflex

### CG2 Tile Grout for Walls\*

**JOINTS:** up to 5mm

#### USE FOR:

- protecting against bacteria and black mould
- most tile types, including porcelain
- dry/wet - interior/exterior
- including power showers/swimming pools (NOT food preparation/storage areas)

**POT LIFE AT 20°C:** 30 minutes

**SETS IN:** 24 hours

**COLOURS:** White and Ivory (10kg/3.5kg),

## TYPICAL COVERAGE (per pack):

TILE SIZES:		150x150x5.5mm	200x200x5.5mm
with JOINT WIDTH:		2mm	2mm
SIZES:	10kg	47.9m <sup>2</sup>	63.5m <sup>2</sup>
	3.5kg	16.8m <sup>2</sup>	22.2m <sup>2</sup>

# BAL Microban Silicone



Waterproof and weatherproof

- Excellent adhesion
- Service temperature range: -50°C to +200°C
- Contains Microban® antibacterial protection: for extra hygiene

## microseal

### Anti-Mould Silicone Sealant for Walls & Floors

#### USE FOR:

- sealing movement joints
- protecting against bacteria and black mould
- most surface types, including acrylic/ceramic/fibreglass/glass/glazed/painted
- dry/wet - interior/exterior

**CURES IN:** 24 hours (per 3mm thickness)

**COLOURS:** White, Grey and Champagne

TYPICAL COVERAGE (per pack):

with **BEAD SIZE:**

**6x6mm**

**SIZE:**

310ml

8.8m

# BAL Superflex Sandstone Wide Joint Grout



- Extra flexibility/bond strength
- Water/frost-resistant

## Superflex Sandstone Wide Joint

### CG2 Tile Grout for Walls\*

**JOINTS:** up to 5mm

#### USE FOR:

- most tile types, including porcelain
- dry/wet - interior/exterior
- including swimming pools/power showers

**POT LIFE AT 20°C:** 30 minutes

**SETS IN:** 24 hours

**COLOURS:** White and Ivory

TYPICAL COVERAGE (per pack):

TILE SIZES:		150x150x5.5mm	200x200x5.5mm
with JOINT WIDTH:		2mm	2mm
SIZES:	10kg	47.9m <sup>2</sup>	63.5m <sup>2</sup>
	3.5kg	16.8m <sup>2</sup>	22.2m <sup>2</sup>

# Durabond Multi-Flex

Fast setting flexible floor tile  
Adhesive

Polymer Modified

Sets in 3 Hours

Fixes to Plywood overlay

White or Grey



# Bondmaster Rapidset Flexible

- ✓ A rapid-setting thin and thick-bed powder based adhesive
- ✓ Suitable for Under Floor Heating
- ✓ It is suitable for fixing floor and wall tiles (glazed interior and exterior areas including patios)
- ✓ Tiles can be grouted 3 hours after fixing
- ✓ The set adhesive is frost and water resistant and can be used in showers, or under continuous immersion such as swimming pools
- ✓ Available in Grey and White



# Dunlop Large Format & Natural Stone Tile Adhesive

## ADHESION PRODUCTS

### Large Format & Natural Stone Adhesive

- Tile Does Not Sink into Adhesive
- Water Resistant
- Fast Setting
- Can Be Grouted In 3 Hours
- Levels Uneven Floors up to 25mm
- Suitable For Plywood Overlay & Undertile Heating
- For Floor Tiling Only

**Colour / Size:** Grey - 10kg, 20kg, White - 20kg  
C2F

For Large Format & Natural Stone Tiles On Floors



# Bondmaster Vitrified

- ✓ Is a flexible, non-slip, water and frost-resistant tile adhesive
- ✓ Suitable for fixing all types of ceramic wall and floor tiles, mosaics, marble, terrazzo, natural stone, brick slips and rigid foam insulating materials
- ✓ Suitable for interior and exterior locations
- ✓ It also provides enhanced adhesion to fully vitrified/ porcelain tiles and to low porosity substrates
- ✓ Suitable for use in showers and swimming pools.



# Bondmaster Flexible Grout

- ✓ Is a water and frost-resistant powder-based grout with increased flexibility
- ✓ Suitable for grouting ceramic, porcelain, and mosaic wall tiles with joint widths up to 5mm
- ✓ Ideal for natural stone, glass, ceramic, mosaic, glazed and porcelain tiles
- ✓ Suitable for interior and exterior use including power showers and swimming pools
- ✓ Sets in 24 hours.



# DURABOND LATEX

Modified Floor Levelling Compound

High Tensile Strength

Rapid Drying

Easy To Use

25kg Bag

Max 5mm

- 3kg per m<sup>2</sup> at 2mm thickness (25kg&5 litres will cover approx 8m<sup>2</sup>)
- 7.5kg per m<sup>2</sup> at 5mm thickness (25kg& 5 litres will cover approx 3.3m<sup>2</sup>).



# ARDEX X7G Plus

- ✓ Grey Flexible Adhesive with Built-In Admix for Floor and Wall Tiling
- ✓ Specifically formulated to have a very high yield per bag (Ceram Research has confirmed approximately 20% more coverage per kg compared to traditional tile adhesives)
- ✓ Enhanced properties of adhesion and flexibility
- ✓ Ideal for fixing fully vitrified or porcelain tiles (internal areas only) and other tiles with low porosity as well as glass and porcelain mosaics without the need for an admixture
- ✓ classified as C2 TE (improved cementitious adhesive with additional characteristics, reduced slip and extended open time) in accordance with BS EN 12004.
- ✓ Used for Fixing Stone Panels

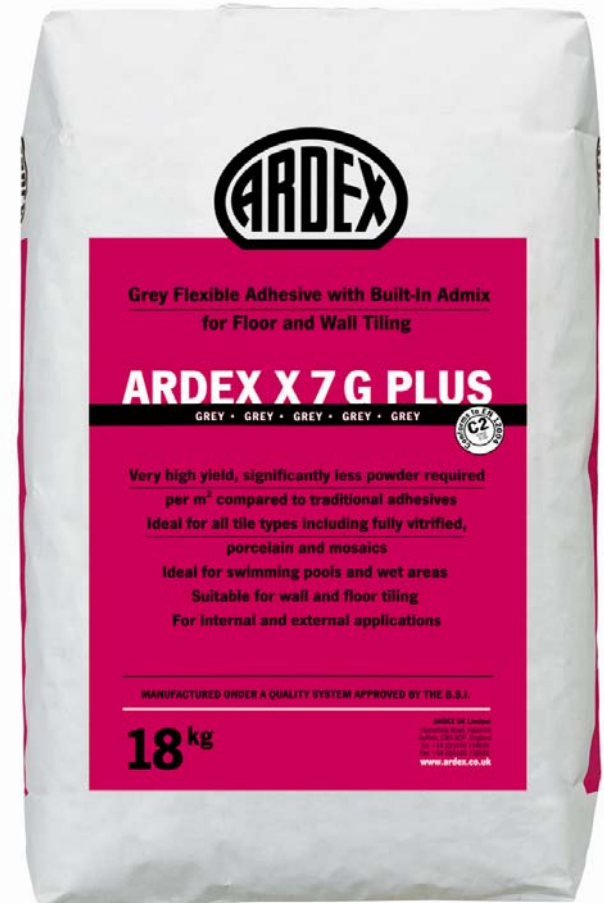

# ARDITEX NA

- ✓ Self-smoothing, protein free latex levelling compound with improved flow and excellent properties of adhesion
- ✓ Flexibility and water resistance
- ✓ Special formulation ARDITEX NA can be used under a damp proof membrane such as ARDEX DPM
- ✓ It is exceptionally easy to mix and produces a very low drag on the trowel during application
- ✓ In addition to these advantages, ARDITEX NA can be laid from a feather edge up to at least 12mm in a single application.
- ✓ Excellent for renovation eg; where old vinyl tiles have been removed

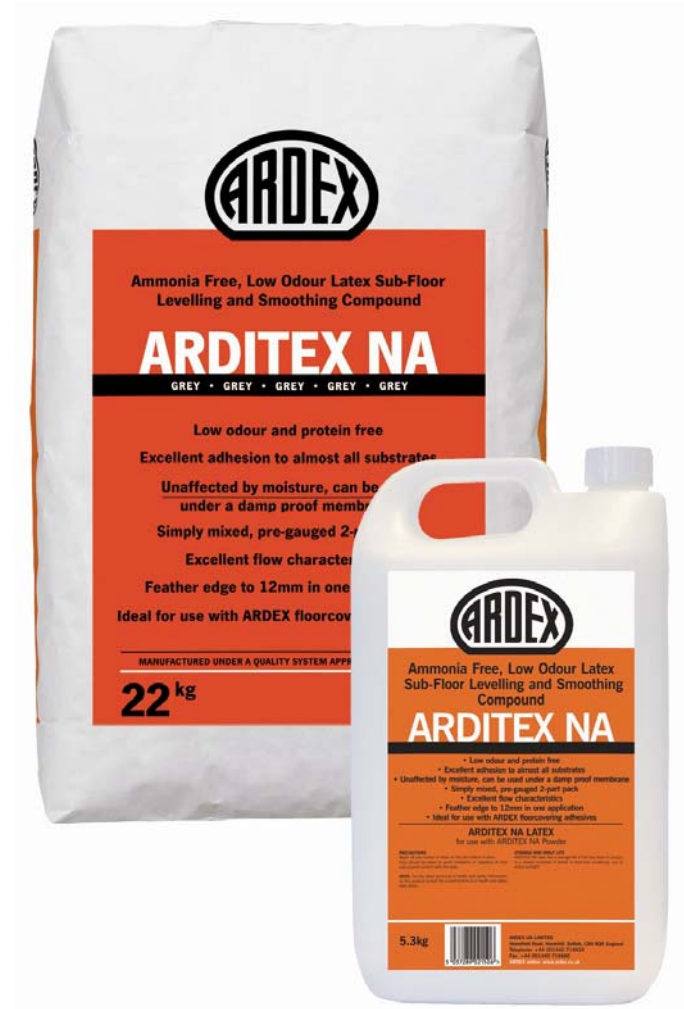

# ARDEX K15

- ✓ Sophisticated self-levelling sub-floor smoothing compound thickness of up to 6cm
- ✓ Can be applied to any thickness by trowel or pump
- ✓ Strong - high compressive strength
- ✓ Suitable for floors with under floor heating
- ✓ Rapidry Formula, walk on after 2 hours (depending on thickness)
- ✓ Even thick applications will be ready to receive floorcoverings within 24 hours at 20°C.

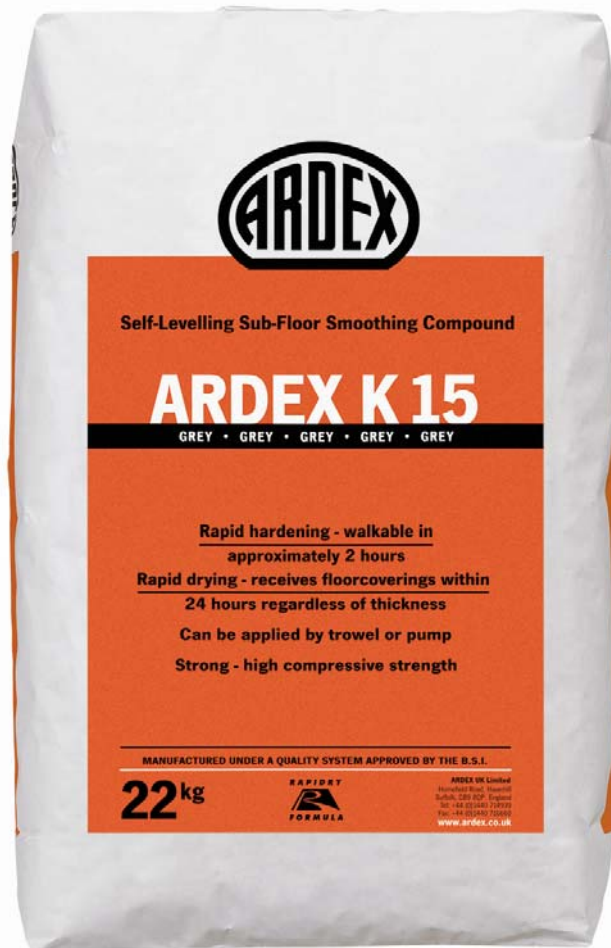

# ARDEX FA 20

- ✓ ARDEX FA 20 is an advanced fibre reinforced smoothing and levelling compound featuring MICROTÉC technology
- ✓ Designed to rapidly smooth and level existing substrates prior to applying a floor finish
- ✓ ARDEX FA 20 can be applied to timber floors, flooring grade asphalt and existing substrates with adhesive residues
- ✓ ARDEX FA 20 can be applied from 3 to 10mm in thickness. For thicknesses greater than 10mm and up to 20mm incorporate suitable aggregate in the mixed mortar.
- ✓ ARDEX FA 20 can normally be walked on after approximately 2 hours at 20°C. Thicknesses up to 10mm are ready to receive floorcoverings within one day at 20°C; thicknesses of 10 to 20mm require 2 days to dry at 20°C.

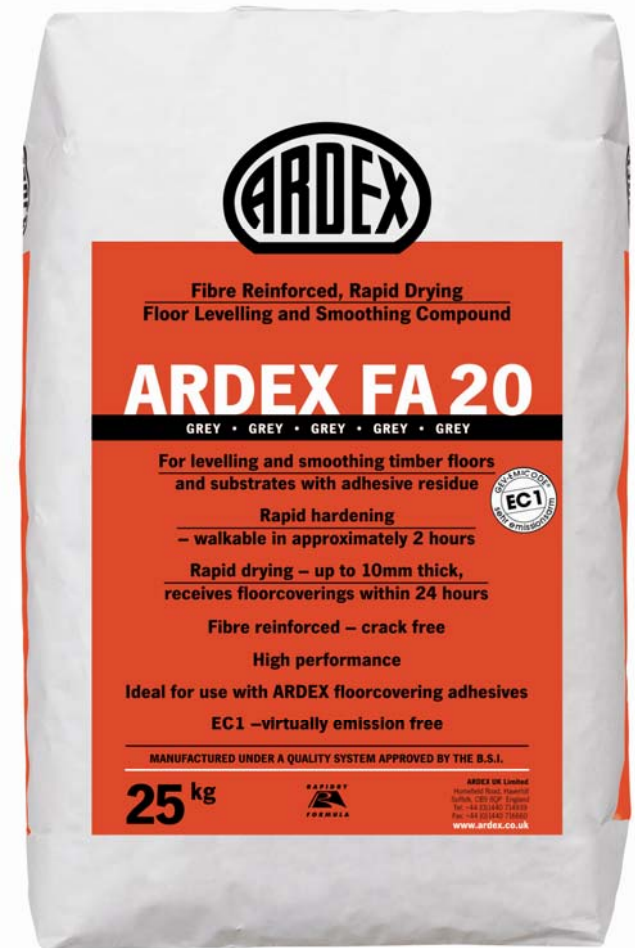



FUNCTION. DESIGN. QUALITY.

- Blanke Permat
- Protects Against Cracking Caused by Deflection
- Tile Directly onto Tongue & Groove (screwed)
- No Need for Ply Overlay
- 3mm Thick

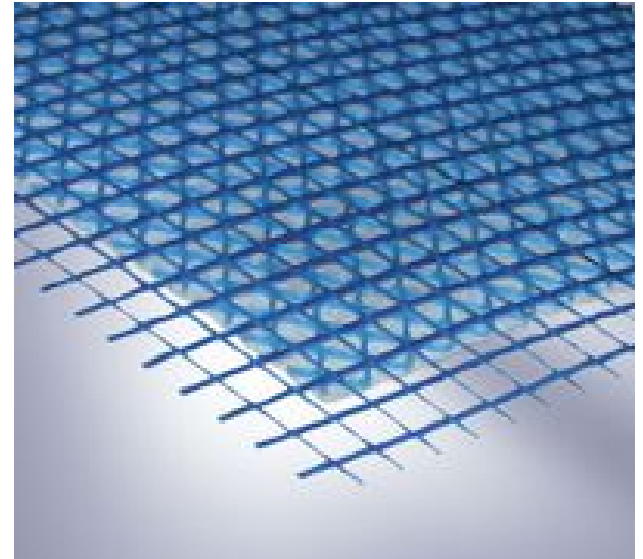



FUNCTION. DESIGN. QUALITY.

- Lay the Fleece side on Flexible C2 Type Adhesive
- Spread Adhesive Filling the Mesh. Possible to walk on During Application
- Tile as Normal





FUNCTION. DESIGN. QUALITY.

- DIBA Waterproofing System
- Waterproofing fabric for sealing substrates under ceramic floorings
- No waiting period to install tile
- Permanent sealing of seams
- Flexible Corners and joint tape





FUNCTION. DESIGN. QUALITY.

- DIBA-DRAIN is a complete shower trap with Sleeve & Grid for thin-bed application
- Construction height of only 70 mm
- Performance of outflow  $\geq 0,80$  l/s
- Incl. an anti-flooding valve
- Odourless even with negative pressure or drying
- Easy connection of the sealing with the floor sleeve
- Waterproof – double security due to adhesion and pressing flange
- Grid can is variable in height and with regards to its sides

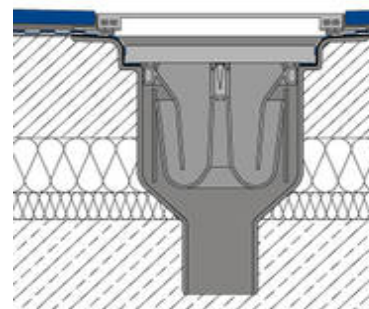
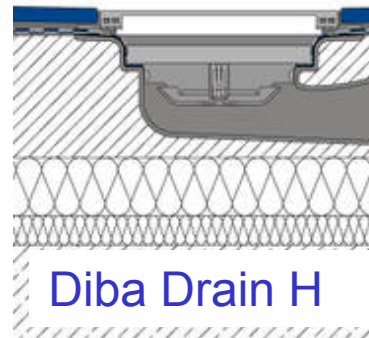



FUNCTION. DESIGN. QUALITY.

- Drain Board
- Drain Board consists of a thermally insulating and highly compressed EPS material with a 2% built in fall
- Has DIBA Waterproof Matting attached with 7cm overhang to allow overlap
- Has built in sleeve and Rebate to receive the Diba Drain
- Suitable for Wheelchairs

